

Photoelectrics Retro-reflective, Polarized Type PB3P

CARLO GAVAZZI



- Range: 3 m
- Polarized modulated, visible red light
- For transparent glass detection
- Adjustable sensitivity
- Rated operational voltage: 10 to 30 VDC
- Output: 200 mA, NPN or PNP
- Make and break switching funct., with LED indication
- Protection: Reverse polarity, short circuit, overload
- Operating frequency: 1 kHz
- High immunity to ambient light
- 18 x 75 x 36 mm ABS housing, IP 67



Product Description

Polarized, retro-reflective photoelectric switch. Range 3 m. Reliable detection of shiny and transparent objects. Visible beam allows easy alignment. Precise detection through narrow beam. Rugged, glass-reinforced ABS housing, totally sealed. IP 67. 2 m PVC cable connection or standard M12 plug.

Ordering Key

PB3P NPA-1

Type _____
 Function _____
 Output type _____
 Connection type _____

Type Selection

Housing W x H x D Rated operating dist. (S _n)	Ordering no. NPN/cable Make & break swit.	Ordering no. NPN/plug Make & break swit.	Ordering no. PNP/cable Make & break swit.	Ordering no. PNP/plug Make & break swit.
18 x 75 x 36 3 m	PB 3P NPA	PB 3P NPA-1	PB 3P PPA	PB 3P PPA-1

Note: Plugs and reflectors to be ordered separately.

Specifications

Rated operating dist. (S_n)	3 m, with reflector type ER 100, ref. target	Light spot size	65 mm at 2 m
Temperature drift	0.4%/K	Ambient light	Max. 10,000 lux
Rated operational volt. (U_B)	10 to 40 VDC (ripple incl.)	Operating frequency (f)	1000 Hz, light/dark ratio 1:2
Ripple (U_{rpp})	10%	Response time	
Output current		OFF-ON (t _{ON})	≤ 660 μs
Continuous (I _e)	≤ 200 mA	ON-OFF (t _{OFF})	≤ 330 μs
Short-time (I)	200 mA, Max. load capacity 100 nF	Power ON delay (t_v)	Typ. 100 ms
No load supply current (I_o)	≤ 40 mA	Indication	
OFF-state current (I_i)	Max. 100 μA	Output ON	LED, yellow
Voltage drop (U_d)	≤ 2.5 VDC	Environment	
Protection	Reverse polarity, overload short-circuit, transients	Overvoltage category	III (IEC 60664/60664A; 60947-1)
Transient voltage	≤ 1 kV/0.5 J	Pollution degree	3 (IEC 60664/60664A; 60947-1)
Sensitivity	Adjustable, 20 turn pot	Degree of protection	IP 67 (IEC 60529; 60947-1)
Light source	GaAlAs LED 660nm	Temperature	
Light type	Visible red polarized, modulated	Operating	-20° to +60°C (-4° to 140°F)
Optical angle	± 1°	Storage	-30° to +70°C (-22° to 158°F)



Specifications (cont.)

Vibration	10 to 150 Hz, 0.5 mm/7.5 g (IEC 60068-2-6)
Shock	2 x 1 m & 100 x 0.5 m (IEC 60068-2-32)
Dielectric voltage	500 VAC (rms)
Housing material	Body: ABS, glass-reinforced, grey Front: ABS, glass-reinforced, black Lenses: Acrylic Mounting bracket ABP-1: Iron, black
Connection	
Cable	Black, 2 m, oilproof PVC, 4 x 0.35 mm ² , Note: Other lengths on request
Plug	CONH1A-..
Weight	197 g cable version 105 g plug version
CE-marking	Yes (only PB3PP..)

Truth Table

	Make switching		Break switching	
	Yes	No	Yes	No
Object present	Yes	No	Yes	No
LED	OFF	ON	OFF	ON
Load	Non-active	Active	Active	Non-active
Output NPN	High	Low	Low	High
Output PNP	Low	High	High	Low

Wiring Diagrams

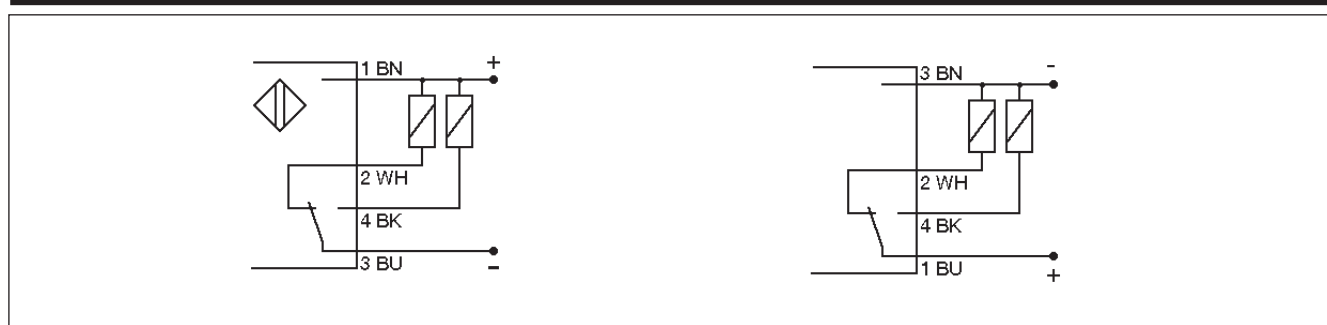

Dimensions

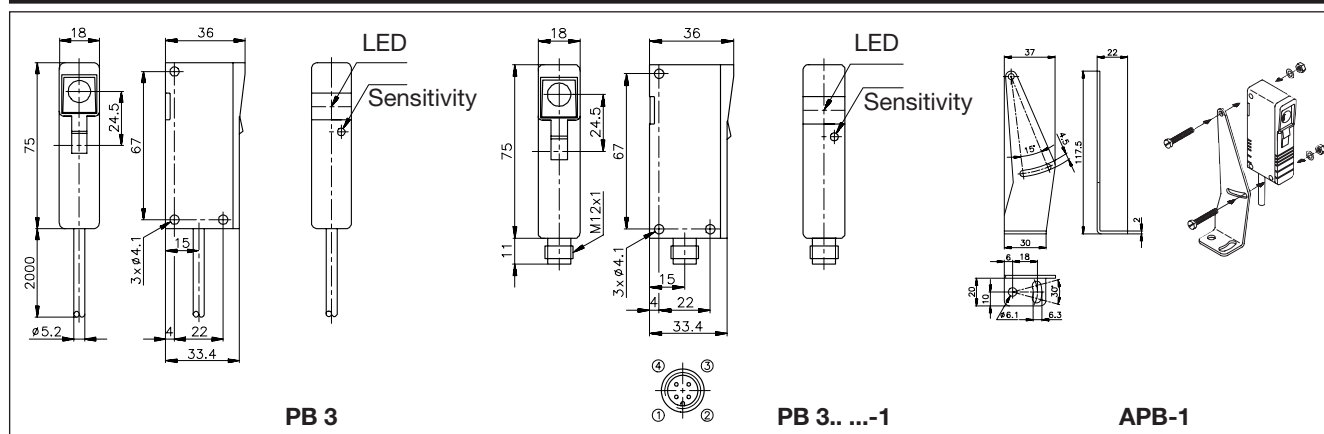

Operation Diagram (Make switching (NO))

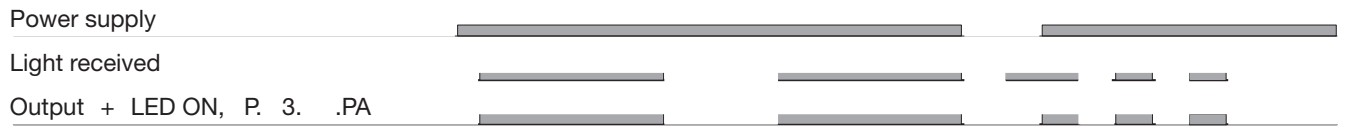

Installation Hints

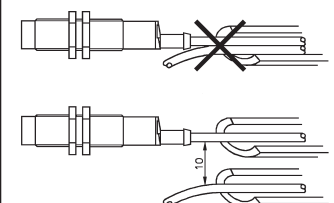
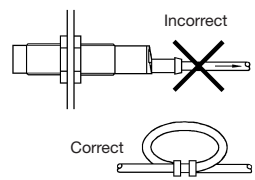
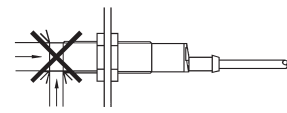
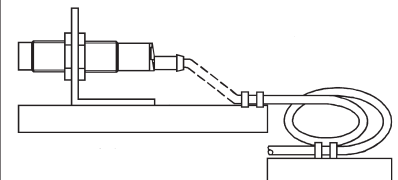
<p><i>To avoid interference from inductive voltage/current peaks, separate the prox. switch power cables from any other power cables, e.g. motor, contactor or solenoid cables</i></p> 	<p><i>Relief of cable strain</i></p>  <p>Incorrect</p> <p>Correct</p> <p>The cable should not be pulled</p>	<p><i>Protection of the sensing face</i></p>  <p>A proximity switch should not serve as mechanical stop</p>	<p><i>Switch mounted on mobile carrier</i></p>  <p>Any repetitive flexing of the cable should be avoided</p>
--	--	---	---

Accessories

- Reflectors: ER series.
- Connector type CONH1A-... serie.

Delivery Contents

- Photoelectric switch: PB3P.
- Adjustable mounting bracket APB-1
- Screwdriver for adjustments, 77-000
- Installation instruction
- Two M4 x 25 mm screws, washers and M 4 nuts
- **Packaging:** Carton box